

## 5 Maintenance

Warnings and Cautions	40
Simple Repairs - Maintenance	42
Clean the Instrument	43
Assemble the Main Cover	44
Check and Change the Power Fuses	45

This chapter describes the maintenance of the module.



sales@apexscientific.ie  
tel. 01 6854686

## Warnings and Cautions

### WARNING

#### *Open main cover*

The following procedures require opening the main cover of the vacuum degasser.

- To prevent personal injury, remove the power cable from the vacuum degasser before opening the cover.
  - Do not connect the power cable to the vacuum degasser while the covers are removed.
- 

### WARNING

#### **Toxic, flammable and hazardous solvents, samples and reagents**

The handling of solvents, samples and reagents can hold health and safety risks.

- When working with these substances observe appropriate safety procedures (for example by wearing goggles, safety gloves and protective clothing) as described in the material handling and safety data sheet supplied by the vendor, and follow good laboratory practice.
  - The volume of substances should be reduced to the minimum required for the analysis.
  - Do not operate the instrument in an explosive atmosphere.
- 

### CAUTION

Electronic boards and components are sensitive to electrostatic discharge (ESD).

ESD can damage electronic boards and components.

- Be sure to hold the board by the edges, and do not touch the electrical components. Always use ESD protection (for example, an ESD wrist strap) when handling electronic boards and components.
-

**CAUTION**

The sheet metal plates of the degasser are very thin.

Although they have been deburred, they are still quite sharp. You may cut your hands or fingers.

→ Never slide your fingers along the edges of the enclosure.

---

**WARNING**

*Instrument is partially energized when switched off*

**The power supply still uses some power, even if the switch on the front panel is turned off.**

→ To disconnect the vacuum degasser from line, unplug the power cord.

---

## **5 Maintenance**

### **Simple Repairs - Maintenance**

## **Simple Repairs - Maintenance**

The degasser is designed for easy repair. The most frequent repairs such as exchanging power fuses can be performed by the user, and don't require opening the main cover of the degasser. These repairs are described in this chapter.

## Clean the Instrument

### WARNING

**Liquid dripping into the electronic compartment of your module can cause shock hazard and damage the module**

- Do not use an excessively damp cloth during cleaning.
  - Drain all solvent lines before opening any connections in the flow path.
- 

The vacuum degasser case should be kept clean. Cleaning should be done with a soft cloth slightly dampened with water or a solution of water and a mild detergent. Do not use an excessively damp cloth that liquid can drip into the vacuum degasser.

## Assemble the Main Cover

**When** • If cover is broken.

Parts required	p/n	Description
	G7122-68713	Cover kit (includes base, top, left and right)

### CAUTION

Wrong assembly

In case you insert the left or right side in the opposite position, you may not be able to remove the side from the top part.

→ Take care not to mix up left and right side.

### NOTE

The cover kit contains all parts, but it is not assembled.

**1** Place the top part on the bench and insert the left and right side into the top part.

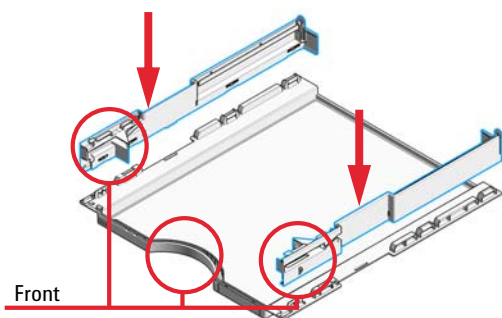

**2** Replace the cover.

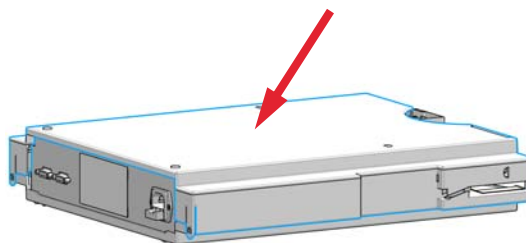

### Next Steps:

- 3** Replace the degasser in the stack and reconnect the cables and capillaries.
- 4** Turn ON the degasser.

## Check and Change the Power Fuses

**When** • If the degasser appears dead

**Tools required**      **Description**  
Test meter  
(if available)

<b>Parts required</b>	<b>#</b>	<b>p/n</b>	<b>Description</b>
	1	2110-0458	Fuse: 250V, T 500 mA , compatible to all supported line voltages

### WARNING

#### Use of unsupplied cables

**Using cables not supplied by Agilent Technologies can lead to damage of the electronic components or personal injury.**

→ Never use cables other than the ones supplied by Agilent Technologies to ensure proper functionality and compliance with safety or EMC regulations.

### NOTE

The module power supply has wide-ranging capability (see [Table 1](#) on page 19). It accepts any line voltage in these ranges. Consequently there is no voltage selector in the rear of the degasser. There are two externally accessible fuses, that protect the power supply. These fuses are identical for all accepted line voltages.

- 1** Switch OFF the power switch at the front of the instrument.
- 2** Remove the power cable from the power connector at the rear of the instrument.

- 3** Press down the clip of the fuse holder.

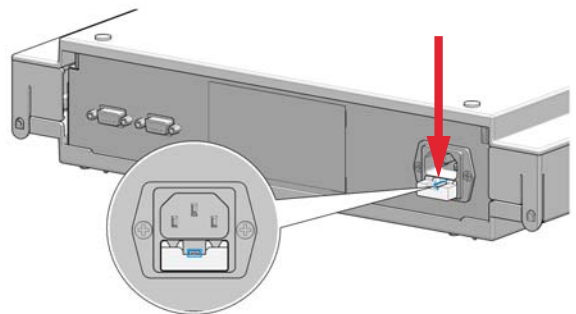

## 5 Maintenance

### Check and Change the Power Fuses

- 4** Pull the fuse holder out of the power socket.

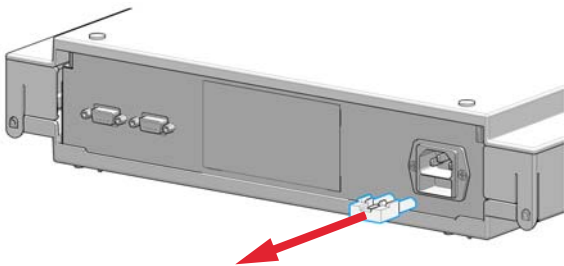

- 5** Remove the fuses from the fuse holders.

**6** Ensure the fuse wires inside the fuses are not broken. If a test meter is available, check the resistance of each fuse. A good fuse shows a low resistance (approximately 0 Ohm).

**7** If a fuse is defective (wire broken or high resistance), insert a new fuse.

- 8** Reinsert the fuse holders and the power cable.

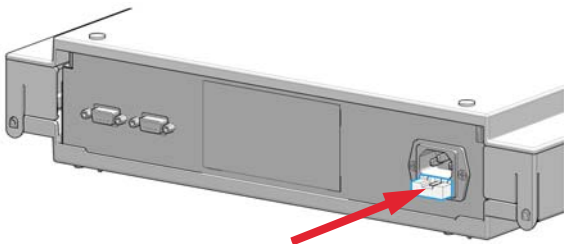

- 9** Switch ON the power switch.



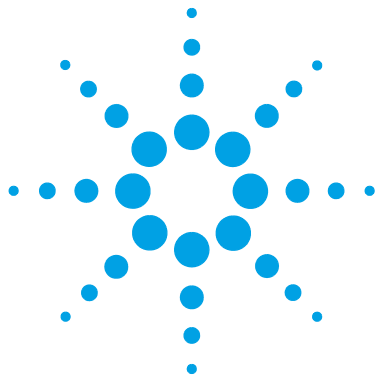

## 6 Parts for Maintenance and Repair

Cover Parts 48

Accessory Kit Contents 50

This chapter provides information on parts for maintenance.



## Cover Parts

The Cover kit (G7122-68713) contains the following parts:

<b>Item</b>	<b>p/n</b>	<b>Description</b>
1	5067-6219	Degasser Front Panel
2	5043-1414	Leak panel
3	5067-6582	Degasser Side Cover Kit
4	5043-1354	Name Plate 1290 Infinity 2
5	5067-5908	Top Cover
6	5043-0856	Leak Adapter
7	5043-0286	Base Cover
	5041-8387	Tube clip
	5041-8365	Blank plug for unused channels / not shown

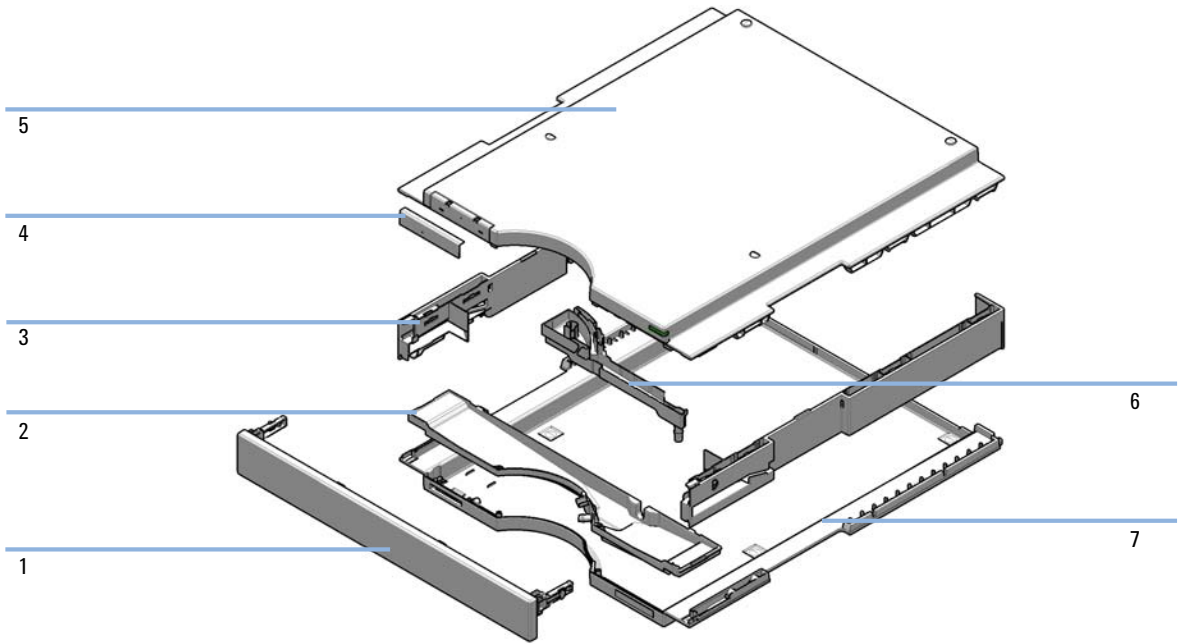
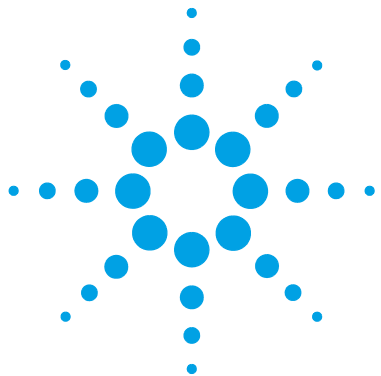

**Figure 7** Cover Parts

## Accessory Kit Contents

### Accessory Kit (G7122-68705)

#	p/n	Description
8	0100-1700	FERRULE-AY-18IN
8	0100-1708	Nut 1/8 PPS
2	5041-8387	Tube clip
2	5043-1013	Tubing Clip
1	0100-1710	Mounting Tool for Tubing Connections
1	9301-1337	Syringe adapter
1	9301-0411	Syringe, Plastic
1	5974-0198	Wire Marker A
1	5974-0199	Wire Marker B
1	5974-0200	Wire Marker C
1	5974-0531	Wire Marker D
1	5974-0015	Wire Marker A1
1	5974-0016	Wire Marker A2
1	5974-0017	Wire Marker B1
1	5974-0018	Wire Marker B2
1	0890-1760	Tubing Flexible, 2 m
1	5188-8045	Remote Cable APG – ERI



## 7 Identifying Cables

Cable Overview	52
Analog Cables	54
Remote Cables	56
CAN/LAN Cables	60
RS-232 Cables	61
USB Cables	62

This chapter provides information on cables used with the Agilent InfinityLab LC Series modules.



## Cable Overview

**NOTE**

Never use cables other than the ones supplied by Agilent Technologies to ensure proper functionality and compliance with safety or EMC regulations.

### Analog cables

p/n	Description
35900-60750	Agilent 35900A A/D converter
01046-60105	Analog cable (BNC to general purpose, spade lugs)

### Remote cables

p/n	Description
5188-8029	ERI to general purpose
5188-8044	Remote Cable ERI – ERI
5188-8045	Remote Cable APG – ERI
5061-3378	Remote Cable to 35900 A/D converter
01046-60201	Agilent module to general purpose
5188-8057	Fraction Collection ERI remote Y-cable

### CAN cables

p/n	Description
5181-1516	CAN cable, Agilent module to module, 0.5 m
5181-1519	CAN cable, Agilent module to module, 1 m

**LAN cables**

p/n	Description
5023-0203	Cross-over network cable, shielded, 3 m (for point to point connection)
5023-0202	Twisted pair network cable, shielded, 7 m (for point to point connection)

**RS-232 cables  
(not for FUSION  
board)**

p/n	Description
RS232-61601	RS-232 cable, 2.5 m Instrument to PC, 9-to-9 pin (female). This cable has special pin-out, and is not compatible with connecting printers and plotters. It's also called "Null Modem Cable" with full handshaking where the wiring is made between pins 1-1, 2-3, 3-2, 4-6, 5-5, 6-4, 7-8, 8-7, 9-9.
5181-1561	RS-232 cable, 8 m

**USB cables**

p/n	Description
5188-8050	USB A M-USB Mini B 3 m (PC-Module)
5188-8049	USB A F-USB Mini B M OTG (Module to Flash Drive)

# Analog Cables

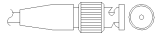

One end of these cables provides a BNC connector to be connected to Agilent modules. The other end depends on the instrument to which connection is being made.

## Agilent Module to 35900 A/D converters

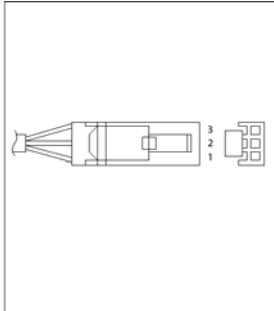
p/n 35900-60750	35900	Pin Agilent module	Signal Name
	1		Not connected
	2	Shield	Analog -
	3	Center	Analog +

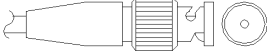

### Agilent Module to BNC Connector

p/n 8120-1840	Pin BNC	Pin Agilent module	Signal Name
	Shield	Shield	Analog -
	Center	Center	Analog +

### Agilent Module to General Purpose

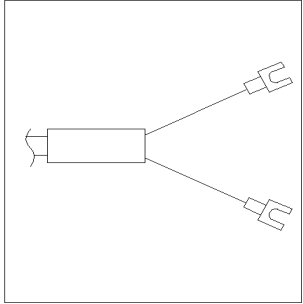
p/n 01046-60105	Pin	Pin Agilent module	Signal Name
	1		Not connected
	2	Black	Analog -
	3	Red	Analog +

## Remote Cables

### ERI (Enhanced Remote Interface)

5188-8029 ERI to general purpose

p/n 5188-8029	pin	Color code	Enhanced Remote	Classic Remote	Active (TTL)
<p>D-Sub female 15way user's view to connector</p>	1	white	I01	START REQUEST	Low
	2	brown	I02	STOP	Low
	3	green	I03	READY	High
	4	yellow	I04	POWER ON	High
	5	grey	I05	NOT USED	
	6	pink	I06	SHUT DOWN	Low
	7	blue	I07	START	Low
	8	red	I08	PREPARE	Low
	9	black	1wire DATA		
	10	violet	DGND		
	11	grey-pink	+5V ERI out		
	12	red-blue	PGND		
	13	white-green	PGND		
	14	brown-green	+24V ERI out		
	15	white-yellow	+24V ERI out		
NC	yellow-brown				

5188-8044 ERI to ERI (Connector D\_Subminiature 15 pin)

**Table 4** 5188-8044 ERI to ERI

p/n 5188-8044	Pin (ERI)	Signal	Pin (ERI)	Active (TTL)
	10	GND	10	
	1	Start Request	1	Low
	2	Stop	2	Low
	3	Ready	3	High
	5	Power on	5	High
	4	Future	4	
	6	Shut Down	6	Low
	7	Start	7	Low
	8	Prepare	8	Low
	Ground	Cable Shielding	NC	

5188-8045 ERI to APG (Connector D\_Subminiature 15 pin (ERI), Connector D\_Subminiature 9 pin (APG))

p/n 5188-8045	Pin (ERI)	Signal	Pin (APG)	Active (TTL)
	10	GND	1	
	1	Start Request	9	Low
	2	Stop	8	Low
	3	Ready	7	High
	5	Power on	6	High
	4	Future	5	
	6	Shut Down	4	Low
	7	Start	3	Low
	8	Prepare	2	Low
	Ground	Cable Shielding	NC	

## 7 Identifying Cables

### Remote Cables

5188-8057 ERI to APG and RJ45 (Connector D\_Subminiature 15 pin (ERI), Connector D\_Subminiature 9 pin (APG), Connector plug Cat5e (RJ45))

**Table 5** 5188-8057 ERI to APG and RJ45

p/n 5188-8057	Pin (ERI)	Signal	Pin (APG)	Active (TTL)	Pin (RJ45)
	10	GND	1		5
	1	Start Request	9	High	
	2	Stop	8	High	
	3	Ready	7	High	
	4	Fraction Trigger	5	High	4
	5	Power on	6	High	
	6	Shut Down	4	High	
	7	Start	3	High	
	8	Prepare	2	High	
	Ground	Cable Shielding	NC		



One end of these cables provides a Agilent Technologies APG (Analytical Products Group) remote connector to be connected to Agilent modules. The other end depends on the instrument to be connected to.

### Agilent Module to Agilent 35900 A/D Converters

p/n 5061-3378	Pin 35900 A/D	Pin Agilent module	Signal Name	Active (TTL)
	1 - White	1 - White	Digital ground	
	2 - Brown	2 - Brown	Prepare run	Low
	3 - Gray	3 - Gray	Start	Low
	4 - Blue	4 - Blue	Shut down	Low
	5 - Pink	5 - Pink	Not connected	
	6 - Yellow	6 - Yellow	Power on	High
	7 - Red	7 - Red	Ready	High
	8 - Green	8 - Green	Stop	Low
	9 - Black	9 - Black	Start request	Low

### Agilent Module to General Purpose

p/n 01046-60201	Wire Color	Pin Agilent module	Signal Name	Active (TTL)
	White	1	Digital ground	
	Brown	2	Prepare run	Low
	Gray	3	Start	Low
	Blue	4	Shut down	Low
	Pink	5	Not connected	
	Yellow	6	Power on	High
	Red	7	Ready	High
	Green	8	Stop	Low
	Black	9	Start request	Low

## CAN/LAN Cables

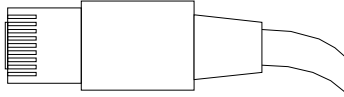

Both ends of this cable provide a modular plug to be connected to Agilent modules CAN or LAN connectors.

### CAN Cables

<b>p/n</b>	<b>Description</b>
5181-1516	CAN cable, Agilent module to module, 0.5 m
5181-1519	CAN cable, Agilent module to module, 1 m

### LAN Cables

<b>p/n</b>	<b>Description</b>
5023-0203	Cross-over network cable, shielded, 3 m (for point to point connection)
5023-0202	Twisted pair network cable, shielded, 7 m (for point to point connection)

## RS-232 Cables

p/n	Description
RS232-61601	RS-232 cable, 2.5 m Instrument to PC, 9-to-9 pin (female). This cable has special pin-out, and is not compatible with connecting printers and plotters. It's also called "Null Modem Cable" with full handshaking where the wiring is made between pins 1-1, 2-3, 3-2, 4-6, 5-5, 6-4, 7-8, 8-7, 9-9.
5181-1561	RS-232 cable, 8 m

## USB Cables

To connect a USB Flash Drive use a USB OTG cable with Mini-B plug and A socket.

<b>p/n</b>	<b>Description</b>
5188-8050	USB A M-USB Mini B 3 m (PC-Module)
5188-8049	USB A F-USB Mini B M OTG (Module to Flash Drive)

